

TRILOGY SOFT SEDIA RUOTE Design Sandrin



TRILOGY SOFT prevede l'utilizzo di sedile e schienale imbottiti. Il comfort di questa versione e la molteplicità dei telai ed accessori disponibili rendono TRILOGY SOFT un elemento d'arredo di assoluto pregio, capace di rendere piacevole qualsiasi momento d'attesa, relax, lavoro o meeting.

FINITURE

SCHIENALE



Nero - RAL 9005



Bianco - RAL 9003



Grigio - RAL 7040

SUPPORTI



Nero - RAL 9005



Bianco - RAL 9003



Grigio - RAL 7040

ACCESSORI

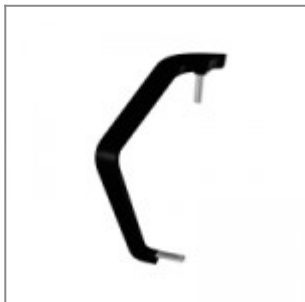

Bracciolo Trilogy, destro guardando, in poliuretano nero

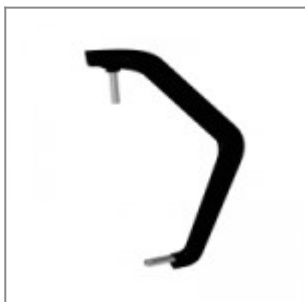

Bracciolo Trilogy, sinistro guardando, in poliuretano nero



Bracc. Trilogy attacco tavoletta, sinistro guardando, in PU nero



Cover sedile Trilogy in polipropilene grigio



Cover sedile Trilogy in polipropilene bianco

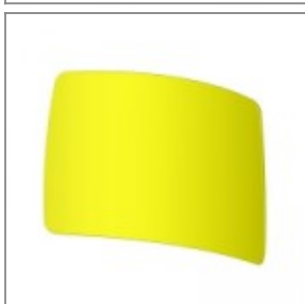

Schienale Trilogy in polipropilene grigio



Schienale Trilogy in polipropilene bianco



Cornice in PP grigio per schienale Trilogy per rete

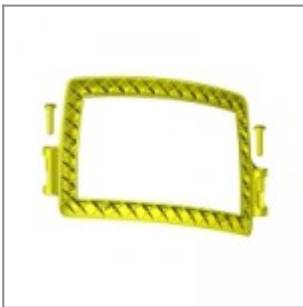

Supporto schienale Trilogy in polipropilene grigio

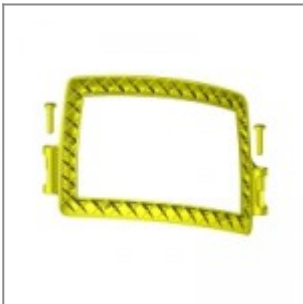

Supporto schienale Trilogy in polipropilene bianco



Carrello di servizio porta-sedia, completo di ruote



Aggancio corto sedia s/braccioli o bracciolo e tav. scritt.



Aggancio lungo sedia con 2 braccioli e tavoletta scrittoio



Snodo antipanico, destro da seduti, per tavoletta scrittoio modd. ZATV10P90, ZATV10L06



Snodo antipanico, sinistro da seduto, per tavoletta scrittoio modd. ZATV10P90, ZATV10L06



Tavoletta scrittoio antipanico, dex e six, in faggio ver.to naturale , utilizzabile con snodi modd. ZASN10P90, ZASN20P90



Tavoletta scrittoio antipanico in ABS nero, dx e sx, utilizzabile con snodi modd. ZASN10P90, ZASN20P90



Snodo con piastra di fiss. in metallo per tavolette scrittoio, dx e sx, per modd. ZTF2635, ZTP2635, ZTF2635DX



Tav. scrittoio sinistra guardando, in faggio ver.to naturale, utilizzabile con snodo ZST15M



Tav. scrittoio destra guardando, in faggio ver.to naturale, utilizzabile con snodo ZST15M



Tavoletta scrittoio sinistra guardando, in PS nero, utilizzabile con snodo ZST15M



Bracciolo Wendy attacco tavoletta, destro guardando, in PU

MISURE

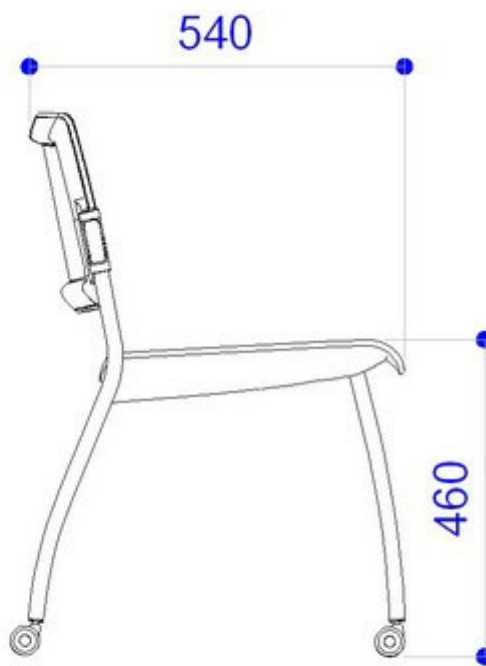
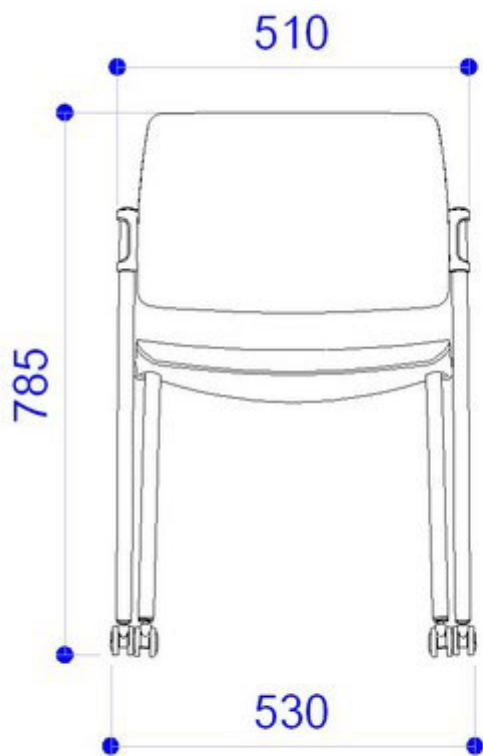

Le dimensioni indicate sono espresse in millimetri (mm) e devono essere considerate solo informative.

The dimensions are indicated in millimetres (mm) and they must be considered only as an informations.

