

laFILÒ SOFT SEDIA Design Alberto Basaglia Natalia Rota Nodari



Famiglia di sedute con struttura in metallo verniciato con polveri epossidiche o cromato. Seduta e schienale in polipropilene stampato ad iniezione con trattamento anti UV. Disponibile la versione autoestinguente. L'aggiunta di un elemento imbottito può rivestire schienale e sedile o solo quest'ultimo. Disponibile anche con braccioli e vari accessori. Ideale per la collettività.

FINITURE

SCHIENALE



Bianco - RAL 9003



Nero - RAL 9005



Cobalt Blue - RAL 5013

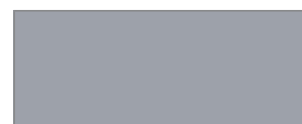

Grigio - RAL 7040



Carmine Red - RAL 3002



Pantone - Sabbia



Pantone - 375C

SEDILE



Bianco - RAL 9003

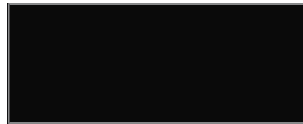

Nero - RAL 9005

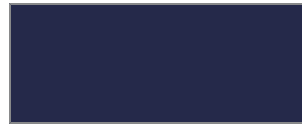

Cobalt Blue - RAL 5013



Grigio - RAL 7040

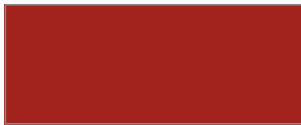

Carmine Red - RAL 3002

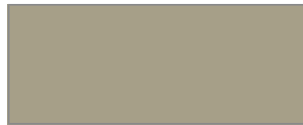

Pantone - Sabbia

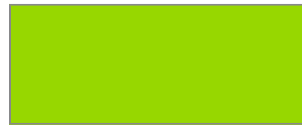

Pantone - 375C

TELAIO



Bianco - RAL 9003

ACCESSORI



Sedile e schienale la Filò in PP anti-UV 300 Klangley color rosso Ral 3002



Sedile e schienale la Filò in PP anti-UV 300 Klangley color blu Ral 5013



Sedile e schienale la Filò in PP anti-UV 300 Klangley color verde Pantone 375C



Sedile e schienale la Filò in PP anti-UV 300 Klangley color grigio Ral 7040



Sedile e schienale la Filò in PP anti-UV 300 Klangley color sabbia



Sedile e schienale la Filò in PP anti-UV 300 Klangley color bianco Ral 9003



Carrello porta sedie in tondino verniciato nero



Aggancio corto in plastica, grigio Ral 7040, per sedie in tondino Ø11 senza braccioli



Aggancio lungo in plastica, grigio Ral 7040, per sedie in tondino Ø11 con braccioli e con tavoletta scrittoio

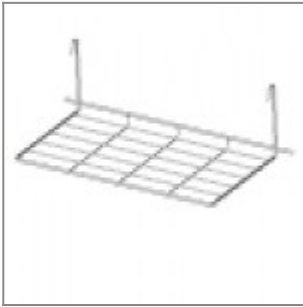

Cestino cromato per sedia trapezio laFilò



Barra distanziatrice laFilò verniciata nera, senza ferramenta



Pattino di scorrimento per pavimentazioni morbide ed irregolari utilizzabile su piedini di telai in tondino

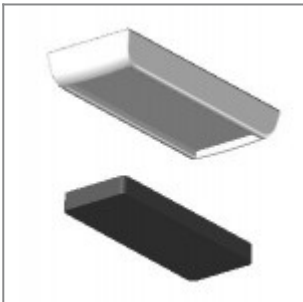

Pattino di scorrimento con feltro per pavimentazioni delicate utilizzabile su piedini di telai in tondino

MISURE

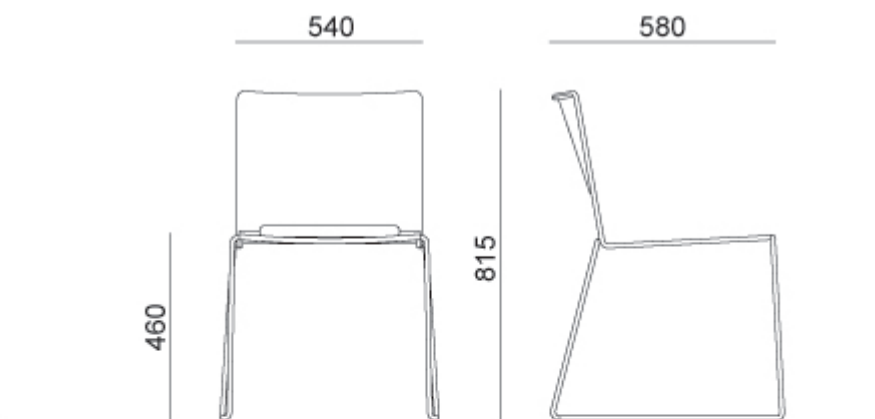

plastic max 40
soft max 15
max 350 kg

plastic max 20
soft max 15

