

# S'MESH PLASTIC SEDIA CON BRACCIOLO Design Alberto Basaglia Natalia Rota Nodari



S'mesh è stata disegnata pensando alle singole occasioni in cui trascorriamo del tempo seduti: in ufficio, nelle sale d'attesa e durante le conferenze. Il massimo del confort rapportato all'alto livello di industrializzazione è la prerogativa secondo cui è stata progettata. Un prodotto che si assembla senza viti con un sistema brevettato ad incastro, che permette la riduzione dei costi e facilita lo smaltimento a fine vita. Ha una struttura perimetrale in tondino d'acciaio. Seduta e schienale sono in polipropilene nei colori bianco nero e grigio. La rete dello schienale è disponibile nei colori nero, bianco, grigio e a progetto anche verde, rosso, blu e beige.

## FINITURE

### POGGIABRACCIA



Nero - RAL 9005



Bianco - RAL 9003



Grigio - RAL 7040

### SCHIENALE



Grigio - RAL 7040

Bianco - RAL 9003

Nero - RAL 9005

## SEDILE

---



Bianco - RAL 9003



Grigio - RAL 7040



Nero - RAL 9005

## TELAIO

---



Nero - RAL 9005



Bianco - RAL 9003



White Aluminium - RAL  
9006

## ACCESSORI



Carrello porta sedie in tondino verniciato nero

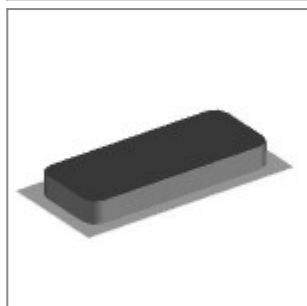

Feltro singolo, marrone, c/adesivo mm 12x30x4 per piedino sedia quattro gambe laKendò ed Eclipse



Aggancio corto in plastica, grigio Ral 7040, per sedie in tondino Ø11 senza braccioli



Aggancio lungo in plastica, grigio Ral 7040, per sedie in tondino Ø11 con braccioli e con tavoletta scrittoio

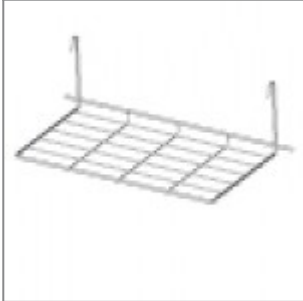

Cestino cromato per sedia trapezio laFilò



Pattino di scorrimento per pavimentazioni morbide ed irregolari utilizzabile su piedini di telai in tondino

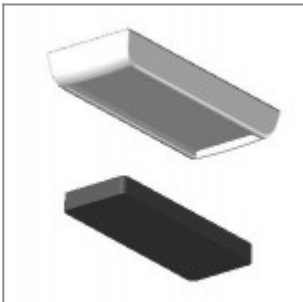

Pattino di scorrimento con feltro per pavimentazioni delicate utilizzabile su piedini di telai in tondino



Rete nera ignifuga per schienale S'mesh



Rete grigia ignifuga per schienale S'mesh



Rete bianca ignifuga per schienale S'mesh

## MISURE

570

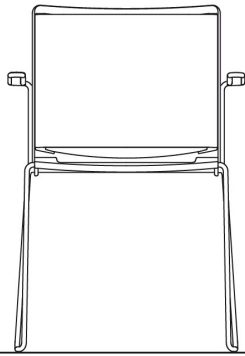

595

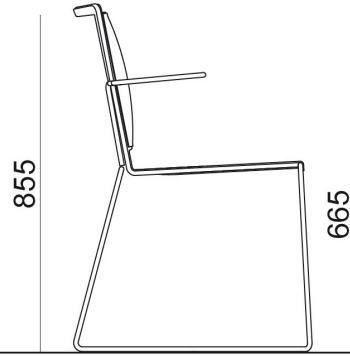

plastic max 20  
soft max 15

plastic max 40  
soft max 15  
max 350 kg

1045

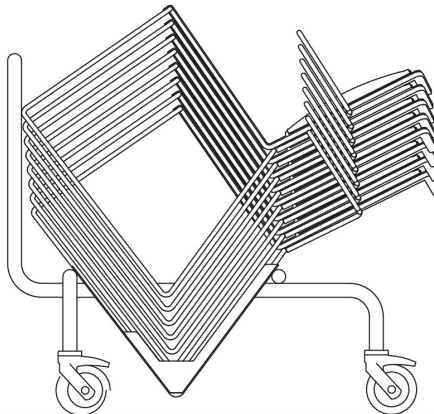
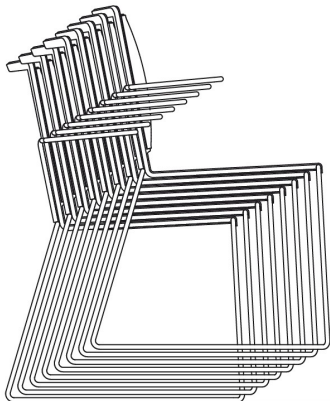

690

