

TRILOGY NET CASTORS CHAIR Design Sandrin



Family of chairs with epoxy-coated or chrome-plated metal frame.

Seat and back in wood or to be upholstered.

Many accessories available.

Ideally suited for waiting areas, conference rooms and as a visitor chair thanks to its classic and neat design.

FINISHES

SUPPORTS



Jet Black - RAL 9005



Signal White - RAL 9003



Window Grey - RAL 7040

ACCESSORIES

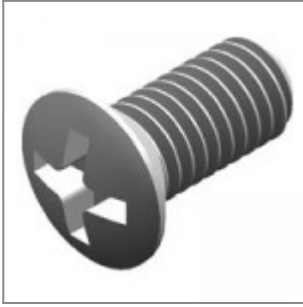

Zinc-coated screw M6 x 20

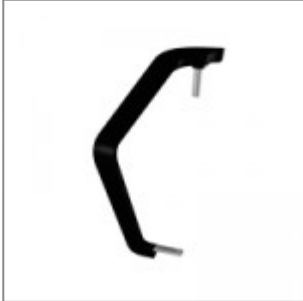

Right arm Trilogy, facing the chair, black polyurethane

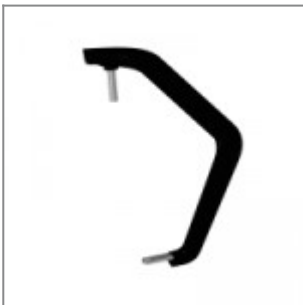

Left arm Trilogy, facing the chair, black polyurethane



Left arm Trilogy for writing tablet, facing the chair, black PU



Gray polypropylene Trilogy seat cover



White polypropylene Trilogy seat cover



Gray polypropylene Trilogy back



White polypropylene Trilogy back



Gray PP Trilogy frame for back for mesh

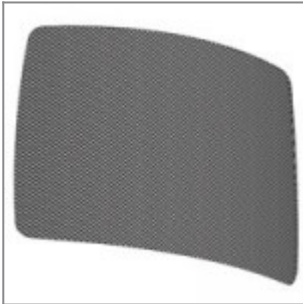

Grey PP Trilogy back with grey mesh

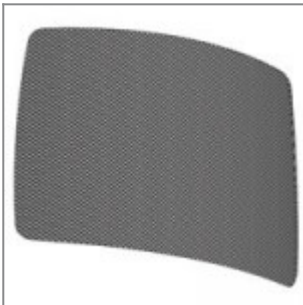

Black PP Trilogy back with black mesh



PP grey Trilogy back with grey mesh assembled



PP black Trilogy back with black mesh assembled



PP white Trilogy back with black mesh assembled

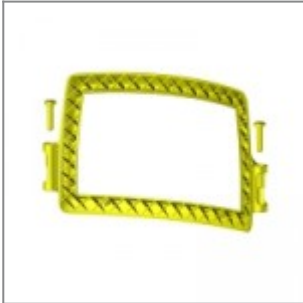

Gray polypropylene Trilogy back support

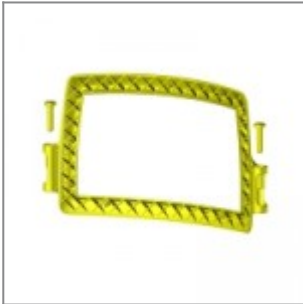

White polypropylene Trilogy back support



Service trolley for chairs, complete with castors



Short linking device for chair or 1 arm and writing tablet



Long linking device for 2 arms chair and writing tablet



Right-hand antipanic joint for writing tablet modd. ZATV10P90, ZATV10L06



Left-hand antipanic joint for writing tablet modd. ZATV10P90, ZATV10L06



Left/Right-hand antipanic writing tablet in varnished beech, suitable with ZASN10P90, ZASN20P90



Left/Right-hand antipanic writing tablet in black ABS, suitable with ZASN10P90, ZASN20P90



Nylon joint with fixing metal plate for writing tablet modd. ZTF2635, ZTF2635DX, ZTP2635



Right-hand varnished beech wood writing tablet, suitable with joint cod. ZST15M



Left-hand varnished beech wood writing tablet, suitable with joint cod. ZST15M



Black PS writing tablet, right-hand, suitable with joint cod. ZST15M



Right polyurethane arm Wendy for writing tablet, facing the chair

DIMENSIONS

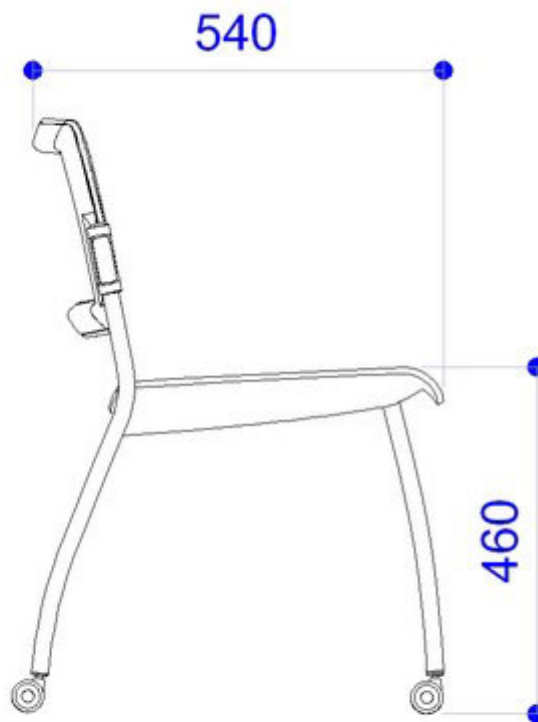
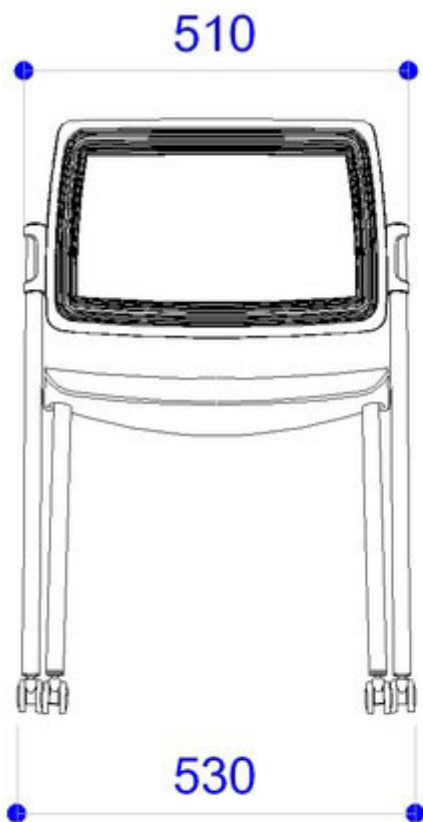

Le dimensioni indicate sono espresse in millimetri (mm) e devono essere considerate solo informative.

The dimensions are indicated in millimetres (mm) and they must be considered only as an informations.

