

laMIA PLASTIC TIP-UP BENCH Design Angelo Pinaffo



Family of chairs with epoxy-coated or chrome-plated metal frame. Seat and back made of anti-UV treated injection moulded polypropylene. Also available in the flame retardant and biodegradable version upon request. Upholstery can be added to the plastic seat and back or just to the seat. Wood and metal complete the range. Wide range of accessories available. Ideal for all public spaces that are intensively used.

FINISHES

ARMREST



Window Grey - RAL 7040

BACK



Pantone - Sand



Pantone - 375C



Pantone - 279C



Pantone - 201C



Jet Black - RAL 9005



Signal White - RAL 9003



Window Grey - RAL 7040

SEAT



Pantone - Sand



Pantone - 375C



Pantone - 279C



Pantone - 201C



Jet Black - RAL 9005



Signal White - RAL 9003



Window Grey - RAL 7040

ACCESSORIES



Aluminium painted metal arm insert for tip-up bench laMia



Black painted metal arm insert for tip-up bench laMia

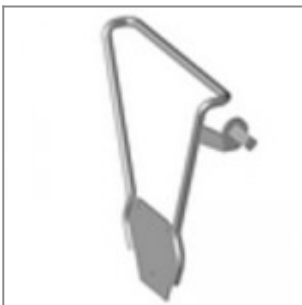

Left handed alum.paint.insert arm for tip-up bench laMia, with pin for writing tablet



Left handed black paint.insert arm for tip-up bench laMia, with pin for writing tablet



Right handed alum.paint.insert arm for tip-up bench laMia, with pin for writing tablet



Right handed black paint.insert arm for tip-up bench laMia, with pin for writing tablet

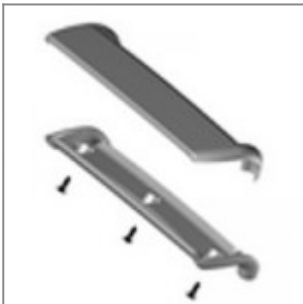

Plastic grey Ral 7040 laMia pad for armrest



Plastic black laMia pad for armrest



Right-hand antipanic joint for writing tablet modd. ZATV10P90, ZATV10L06



Left-hand antipanic joint for writing tablet modd. ZATV10P90, ZATV10L06



Left/Right-hand antipanic writing tablet in varnished beech, suitable with ZASN10P90, ZASN20P90



Left/Right-hand antipanic writing tablet in black ABS, suitable with ZASN10P90, ZASN20P90



Nylon joint with fixing metal plate for writing tablet modd. ZTF2635, ZTF2635DX, ZTP2635

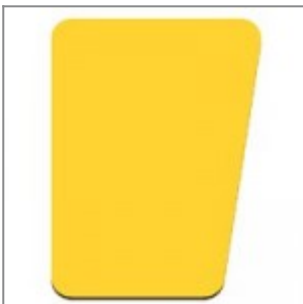

Right-hand varnished beech wood writing tablet, suitable with joint cod. ZST15M



Left-hand varnished beech wood writing tablet, suitable with joint cod. ZST15M



Black PS writing tablet, right-hand, suitable with joint cod. ZST15M



Right handed chromed metal insert laMia with pin for writing tablet



Right handed aluminium painted metal insert laMia with pin for writing tablet



Right handed black painted metal insert laMia with pin for writing tablet



Right handed half dull white Ral9003 painted metal insert laMia with pin for writing tablet



Red Pantone 201C laMia seat and back polypropylene UV-resistant 360 Klangley



Blue Pantone 279C laMia seat and back polypropylene UV-resistant 360 Klangley



Green Pantone 375C laMia seat and back polypropylene UV-resistant 360 Klangley



Grey Ral 7040 laMia seat and back polypropylene UV-resistant 360 Klangley



Sand laMia seat and back polypropylene UV-resistant 360 Klangley



White Ral 9003 laMia seat and back polypropylene UV-resistant 360 Klangley



laMia seat and back in fireproof grey Ral 7040 PP colour



laMia seat and back in fireproof black Ral 9005 PP colour

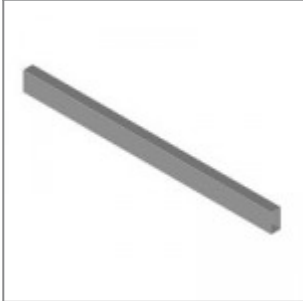

Aluminium painted beam for bench 80x40 L 1030



Black painted beam for bench 80x40 L 1030

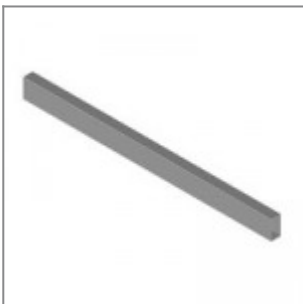

Aluminium painted beam for bench 80x40 L 1130



Black painted beam for bench 80x40 L 1130

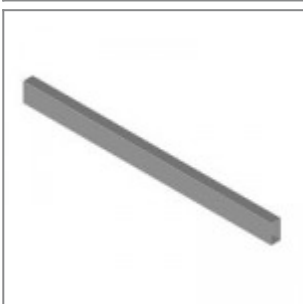

Aluminium painted beam for bench 80x40 L 1550

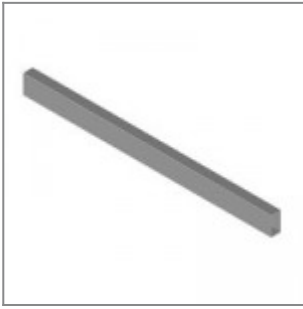

Black painted beam for bench 80x40 L 1550

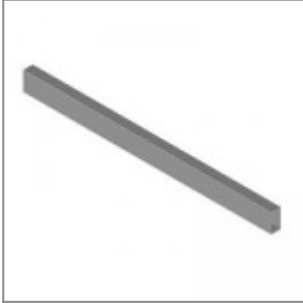

Aluminium painted beam for bench 80x40 L 1750



Black painted beam for bench 80x40 L 1750

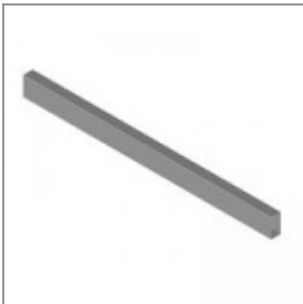

Aluminium painted beam for bench 80x40 L 2070

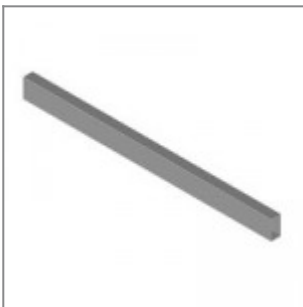

Black painted beam for bench 80x40 L 2070



Aluminium painted beam for bench 80x40 L 2370

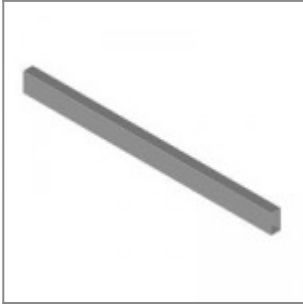

Black painted beam for bench 80x40 L 2370



Aluminium painted beam for bench 80x40 L 2590



Black painted beam for bench 80x40 L 2590



Aluminium painted beam for bench 80x40 L 2990

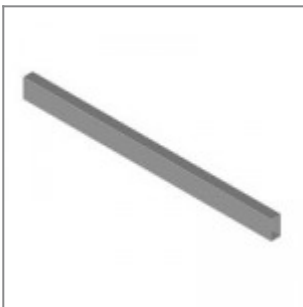

Black painted beam for bench 80x40 L 2990

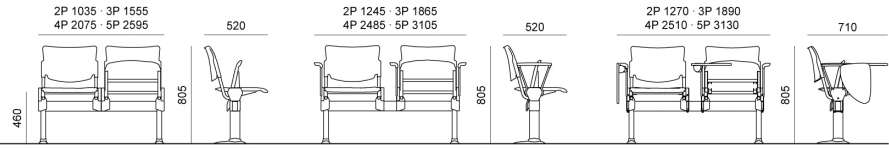

Table top for bench 450x500, bicoloured black and grey

DIMENSIONS

laMIA PLASTIC | EASY SOFT | SOFT | WOOD | METAL . Design Angelo Pinaffo

DIEMMEBI®



PANCA RIBALTABILE | TIP-UP BENCH